

ARIZONA 2PV

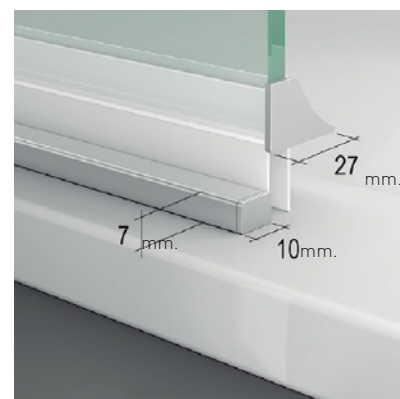

ARIZONA 2PV

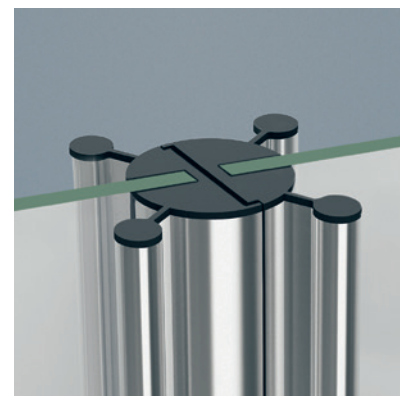
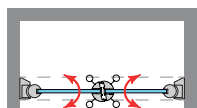
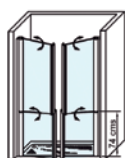

Especialmente diseñada para personas con movilidad reducida. Su apertura exterior deja todo el espacio libre para el acceso a silla de ruedas. La puerta seccionada permite atender a la persona asistida sin temor a salpicaduras de agua.

MEDIDAS MÁXIMAS

- Tirador vertical incorporado al perfil.
- Ancho Máx. Mampara: 140 cm.
- Ancho Máx. de PV: 70 cm.
- Altura Máx.: 205 cm.



Vidrio Securitizado
Espesor 6 mm

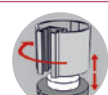

Sistema Elevable
Evita Roce de Gomas

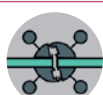

Tirador
Magnético PV

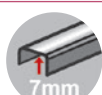

Perfil de Estanqueidad
Alto 7 mm



Vierteaguas
Doble goma barrido

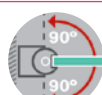

Apertura 180°
90° Interior y 90° Exterior

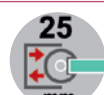

Cerco a pared U-25
Corrige Desnivel 1cm



Adaptado para
silla de ruedas



Altura Normalizada
Ducha