

ESTAMBUL 6 2P

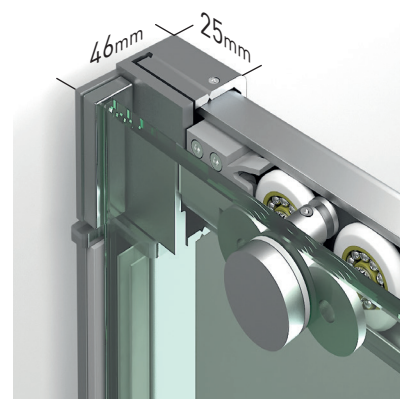

ESTAMBUL 6 2P

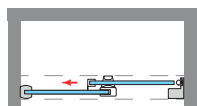
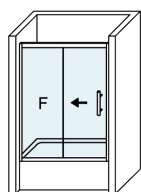

Estambul - 6 mantiene la misma estética y elegancia que su homóloga Estambul - 8. La diferencia del espesor del vidrio unida a un tirador convencional otorga a la colección una excelente relación calidad-precio.
Estambul - 6 , incorpora modelo semicircular.

MEDIDAS MÁXIMAS / MÍNIMAS

- Ancho máx. / mín. Frontal - 200 / 95 cm.
- Ancho máx. Fijo / Puerta - 110 / 90 cm.
- Indicar Mano.



Esesor de vidrio Puerta / Fijo

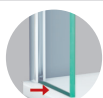

Vidrio Fijo Sin perfil inferior



Liberación de puerta fácil limpieza

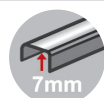

Perfil de Estanqueidad Alto 7 mm

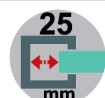

Cerco a pared U-25 Corrige Desnivel 1,5 cm



Doble Rodamiento Suave Deslizamiento

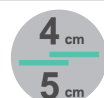

Cruce de puertas Min./ Máx 4/5 cm



Superclean incluido